

ASSEMBLY AND INSTALLATION INSTRUCTIONS

T0589

WARNING: Turn off the main power at circuit breaker before installing fixture.
AVERTISSEMENT: Coupez la source d'alimentation principale au panneau central de disjoncteurs avant d'installer le luminaire.

NOTE: 1. Before installing, consult local electrical codes for wiring and grounding requirements.
2. READ AND SAVE THESE INSTRUCTIONS.

Hardware Package (included):

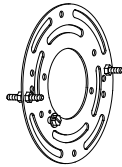

Mounting Plate Unit (A)



Mounting Screw (B)

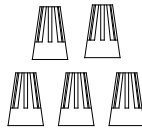

Wire Connector (C)



Bolt Nut (D)



Rubber Pad (E)

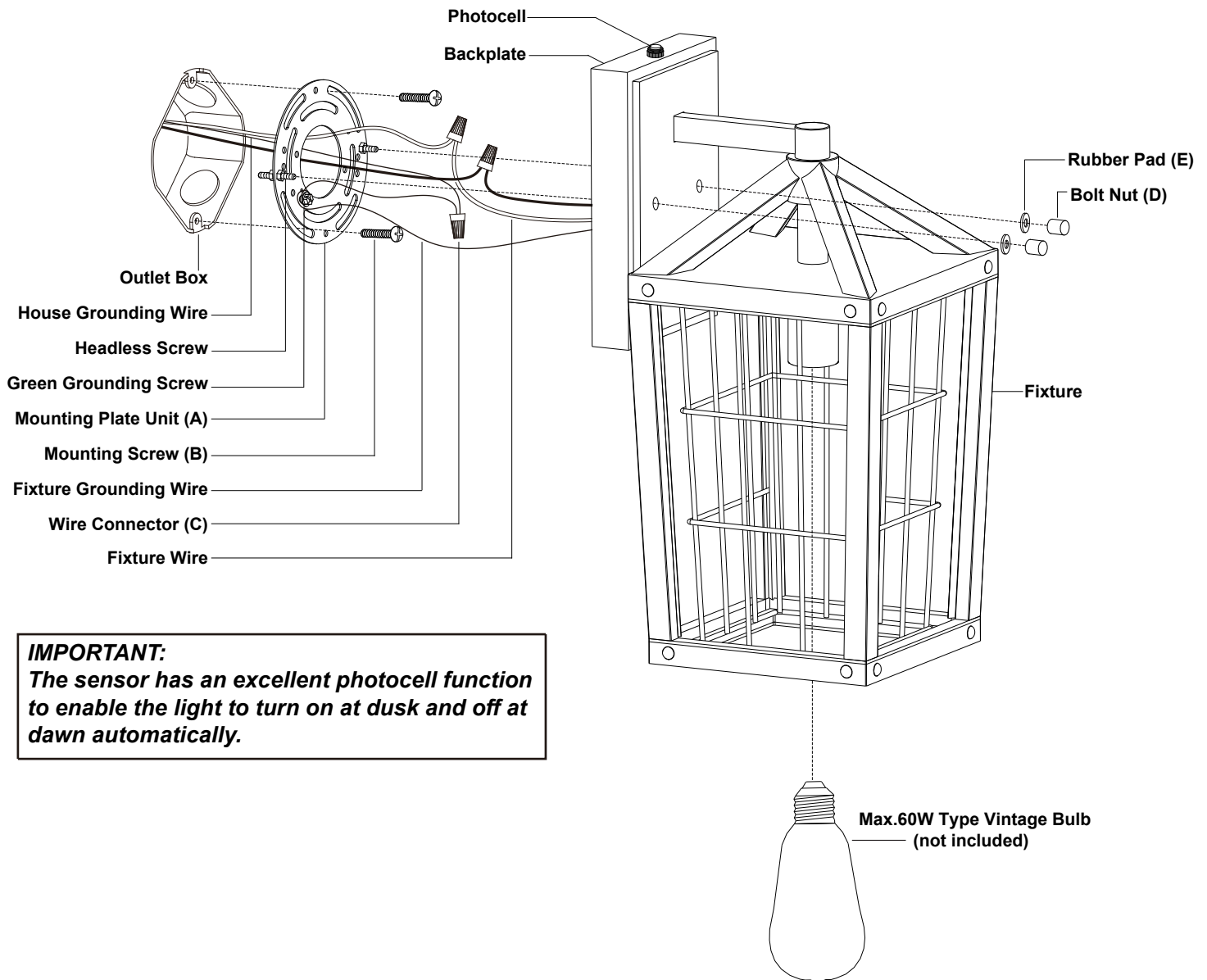

IMPORTANT:

The sensor has an excellent photocell function to enable the light to turn on at dusk and off at dawn automatically.

Installation Steps

Turn off the power at fuse or circuit box.

1. Remove the two bolt nuts (D), the two rubber pads (E) and the mounting plate unit (A) from the backplate.
2. Attach the mounting plate unit (A) to the outlet box by using two mounting screws (B). Adjust the length of the preinstalled headless screws if necessary.
Note: Make sure that two the headless screws lined up horizontally to make the fixture level.
3. Pull out the source wires from the outlet box. Make wire connections using wire connectors (C) as follows:
 - Connect the hot wire (usually black insulation) from the fixture to the black wire from the power source.
 - Connect the neutral wire (usually white insulation) from the fixture to the white wire from the power source.
 - Attach the fixture grounding wire (usually green insulation or bare wire) to the mounting plate unit (A) with the green grounding screw. Then, depending on local code, connect it to the house grounding wire with the wire connector (C). Carefully put all of the wires back into the outlet box.
4. Attach the backplate of the fixture to the mounting plate unit (A) by aligning and inserting the two headless screws from the mounting plate unit (A) into the open holes on the backplate, then place the two rubber pads (E) over the exposed headless screws before screwing the two bolt nuts (D) on the screws.
NOTE: With silicone caulking compound, caulk complete around the backplate meets with the wall surface to prevent water from seeping into the outlet box.
5. Install the bulb (not included). See relamping label at socket area or packaging for maximum wattage allowed.

Turn on the power at fuse or circuit box.

Operating the Unit Without Photocell

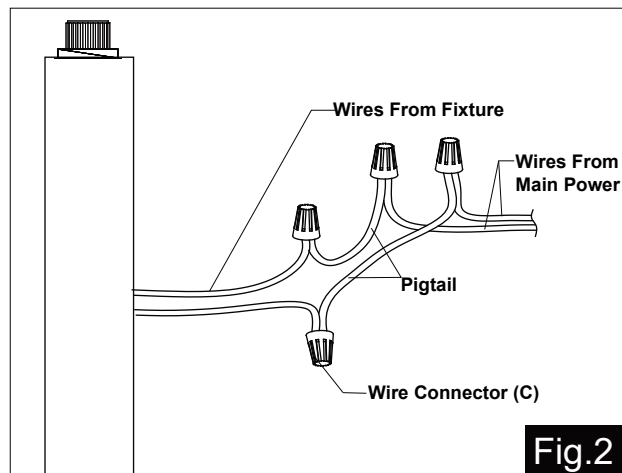
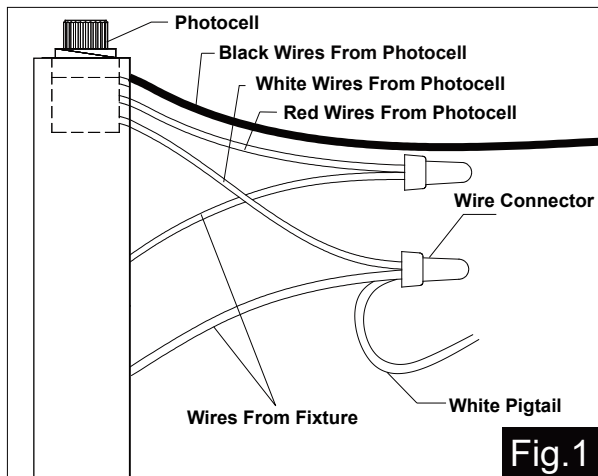

1. Turn off the power at the fuse or circuit box before starting installation.
2. Loosen the wire connector connected with the wires from photocell. (See Fig.1)
Note: Do not remove the photocell to prevent water from seeping into the outlet box.
3. Take a white pigtail and black pigtail and make wire connections using wire connector (C): (See Fig.2)
 - a. The black wire from the fixture to one end of the black pigtail.
 - b. The white wire from the fixture to one end of the white pigtail.
 - c. The other end of the black pigtail to the black wire from the power source.
 - d. The other end of the white pigtail to the white wire from the power source.Put all wires back into the back plate of the fixture.

Turn on the power at fuse or circuit box.

The following parts are available for re-order if damaged or missing.

Spare Parts List:

Mounting Plate Unit (A)	Mounting Screw (B)	Wire Connector (C)	Bolt Nut (D)	Rubber Pad (E)	Glass Panel X4 10203CS

↑ Assembly Kit
6307MM (1 SET)

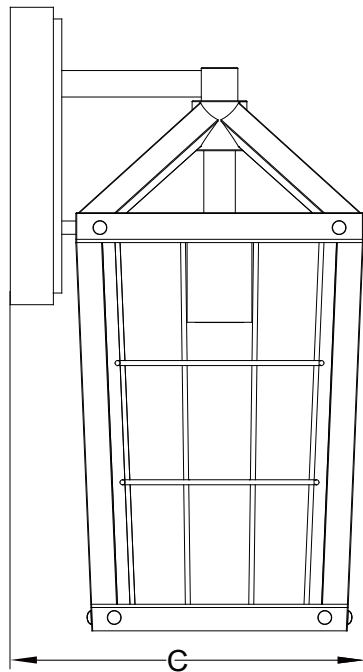
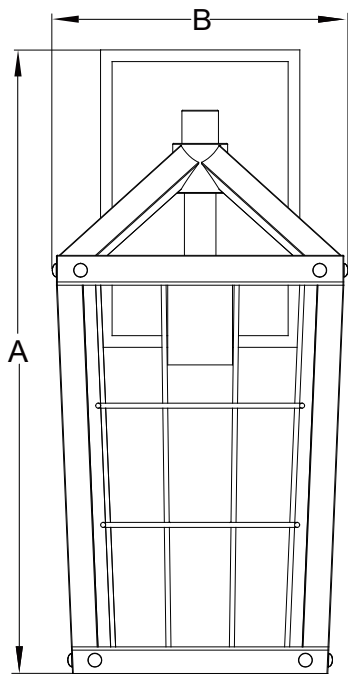

A: 15"
B: 7"
C: 8-1/2"